

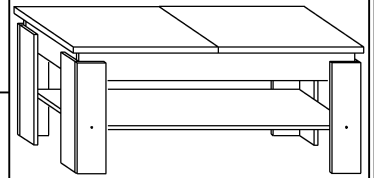









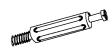

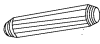

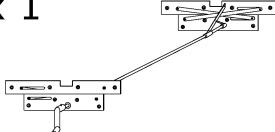

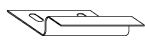
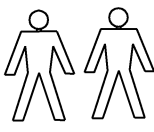

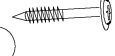

ŁAWA - BOSTON

→ 120/160 ↑ 53/65 ↘ 68



x 12  a	x 12  b	x 12  c	x 28  d	x 4  e			
x 1  f	x 3  g		x 4  h	x 8  i	60 min  		
x 8 (3,5x16)  j	x 16 (6,2x13)  k	x 16 (4x30)  l	x 22 (6,2x13)  m	x 20 (3x13)  n	x 10  o	x 1  p	

1 - FAZY MONTAŻU

A - OZNACZENIE ELEMENTÓW

a - OZNACZENIE AKCESORIÓW

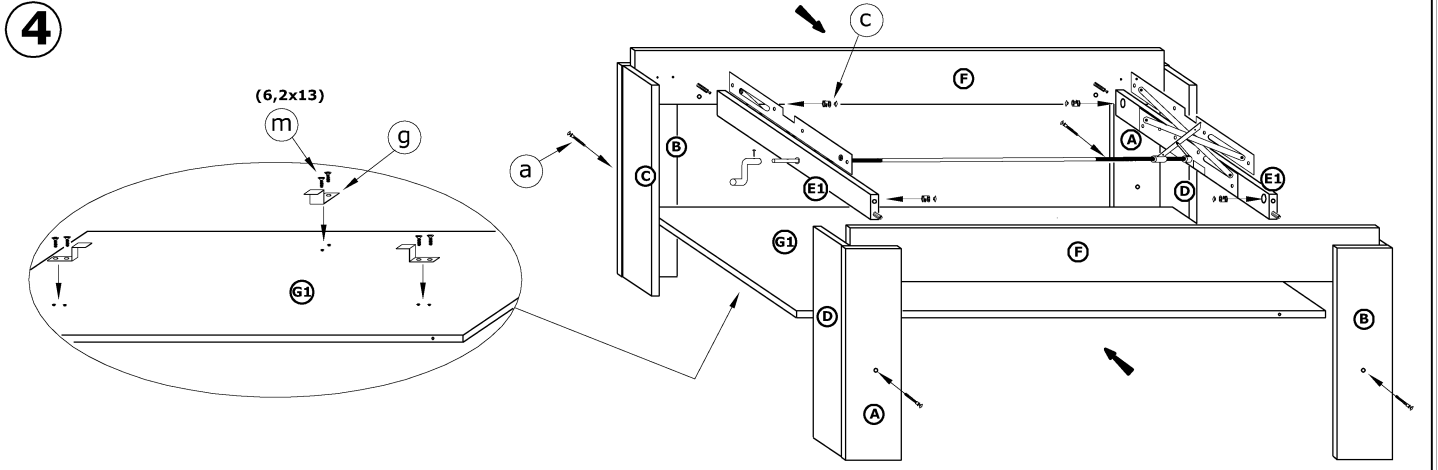
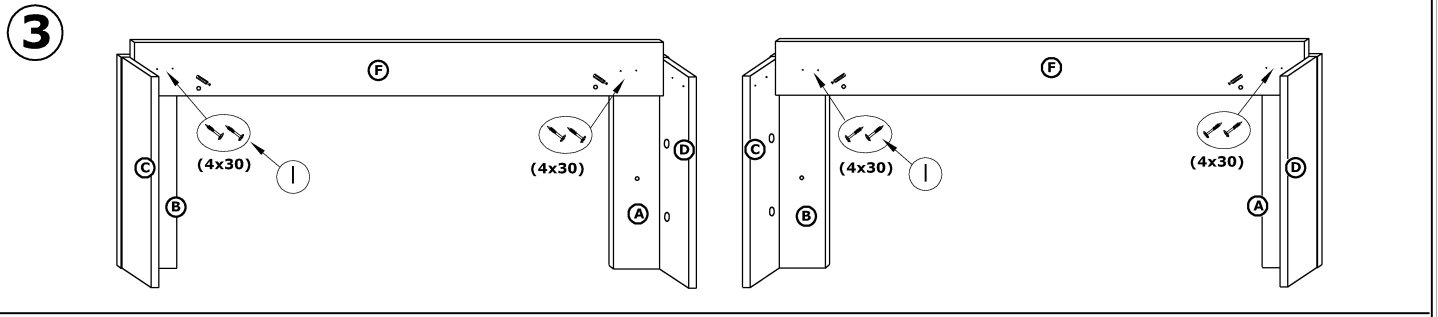
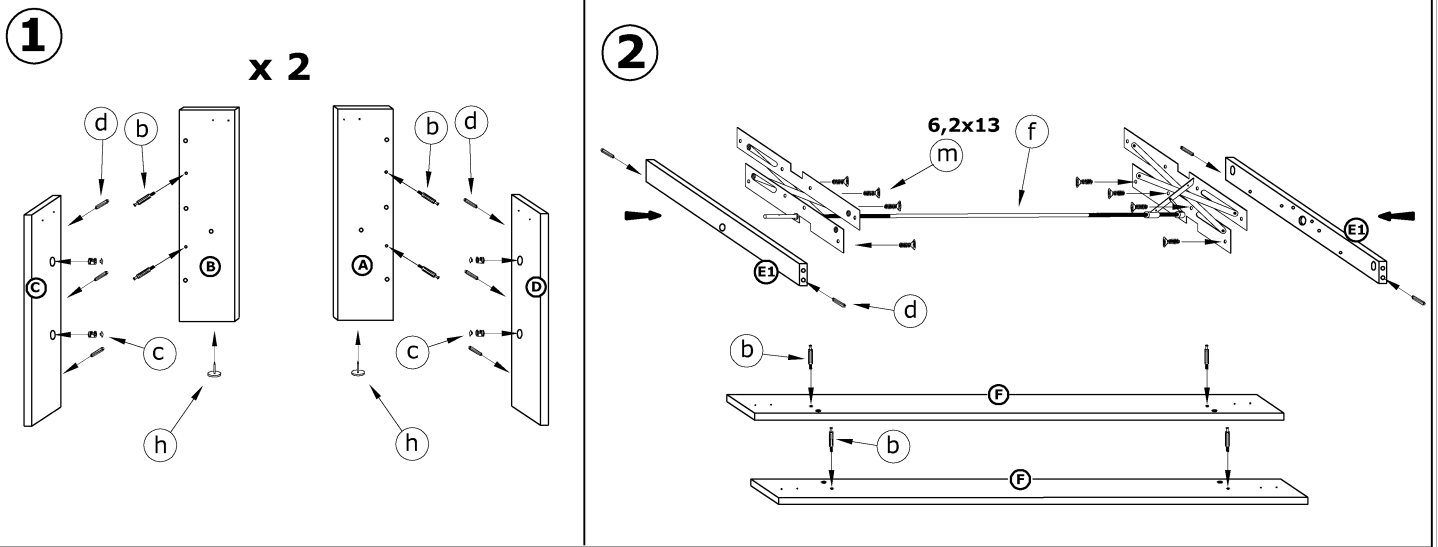

5

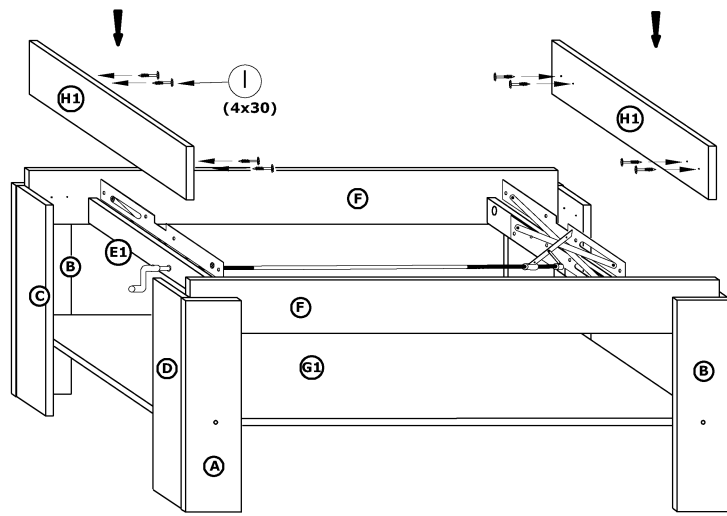

6

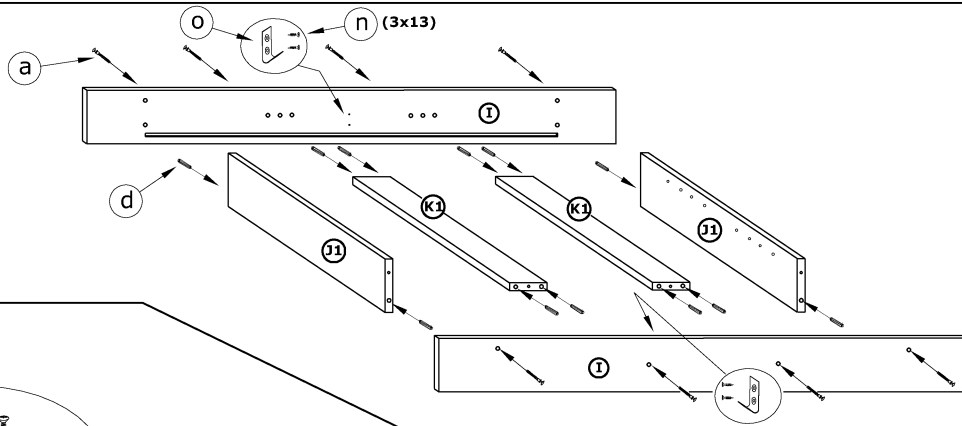

7

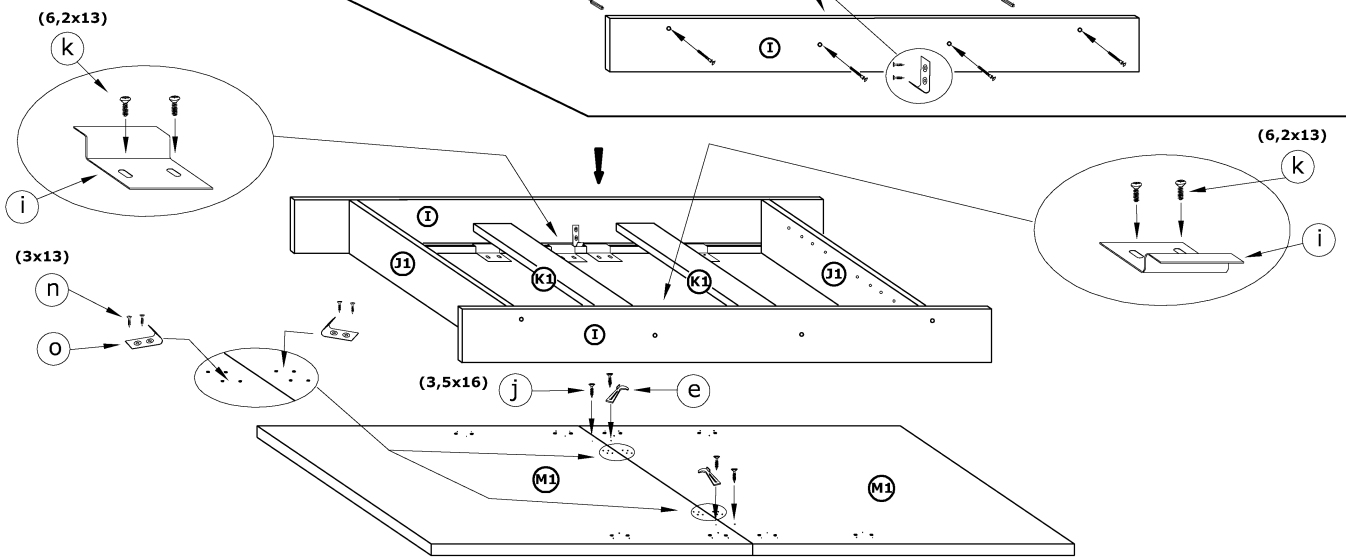

8

